

# CRPP-BMW1.4

User manual

BMW / MINI



CRUISE

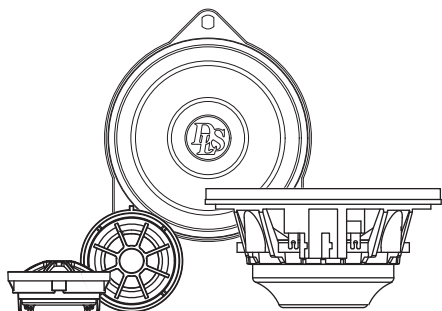

### Welcome to DLS!

Thank you for buying a DLS Cruise CRPP-BMW1.4. For us, it's all about the sound experience. We care deeply about sound and construction quality. In order for your experience to be as optimal as possible, it is important that you fully read this manual, preferably before you start your installation. Keep the manual in a safe and accessible place for future reference.

Your speakers must be installed correctly in order to work as intended. Make sure you have all necessary tools nearby before starting and that you are completely confident in how to proceed. If you feel the slightest uncertainty; feel free to take the help of an experienced installer or a car audio dealer.

### Warranty

This component kit is covered by warranty, depending on the conditions in the country where it is sold. If the product is returned for service, please include the original dated receipt with the product.

### Declaration of conformity

DLS plug and play speakers for vehicles are manufactured in accordance with the EU directive EEC 95/54 (72/245/ EEC) and are marked with the approval number. They are also marked in accordance with the WEEE-directive 2012/19/EC. The products are also produced in accordance with the EU RoHS directive 2015/863/EU.

# DLS CRUISE

## CRPP-BMW1.4

### Content

|                         |    |
|-------------------------|----|
| Welcome                 | 1  |
| Pre-installation        | 2  |
| General info            | 2  |
|                         |    |
| Dismounting door panel  | 3  |
| Removing speaker        | 4  |
| Assemble DLS speaker    | 4  |
| Speaker model A1        | 5  |
| Speaker model A2        | 6  |
| Speaker model B1        | 7  |
| Changing speaker        | 8  |
| High pass filter        | 8  |
|                         |    |
| Removing tweeter        | 9  |
| Changing tweeter        | 10 |
| Remounting door panel   | 10 |
|                         |    |
| Removing rear speaker   | 11 |
| Changing rear speaker   | 11 |
| Removing center speaker | 12 |
| Changing center speaker | 12 |
|                         |    |
| Crossover               | 13 |
| Running-in time         | 13 |
| Specifications          | 14 |
|                         |    |
| Compatible car models   | 16 |
| Product markings        | 18 |

DLS products are engineered by DLS Sweden,  
a part of:

### Winn Scandinavia AB

Elementvägen 15 - SE-702 27 Örebro - Sweden  
Tel: +46 19 20 67 65 - E-mail: info@dls.se  
www.dls.se

**Designed & Sound tuned in Sweden.**



### Included products:

2pcs Midrange speakers  
2pcs Tweeters  
2pcs Crossovers HP tweeter  
2pcs Crossovers HP midrange

### Included in box:

2pcs Plastic adaptors (For type A1 & A2)  
2pcs Steel adaptors (For type B1)  
2pcs Tweeter adaptors (Type A & B)  
2pcs Cable connectors  
4pcs Adhesive foam pads  
2pcs Rubber gaskets  
2pcs EVA gaskets 102mm x 1.5mm  
2pcs EVA gaskets 97mm x 1mm  
2pcs Foam gaskets 115mm x 13mm  
2pcs Foam gaskets 115mm x 4mm  
2pcs Sound optimized tweeter brackets  
8pcs M3 Screws  
1pc Sealing compound  
1pc PRY tool  
1pc Manual

## Pre installation

### Disconnect Battery

Before you start the process of replacing speakers, disconnect and secure the negative terminal from your battery/power source. This will prevent the risk of damaging yourself or the products.

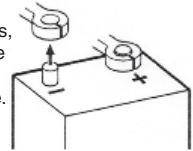

Place the disconnected terminal in a secure and isolated location away from any possible connection belonging to the battery/power source system.

## General info

BMW has many different sound systems and configurations in the same year/model.

This means that there are several different setups that can be installed in the same models. There can be different speakers in the front door, back door, rear shelf, side panel and center in the dash board.

Before you begin with the installation, take a few minutes to check what kind of speaker you have in your car. For this reason there can be a need for different tool, such as.

- Bit screwdriver
- Bit mini ratchet
- T15/T20 Torx bit
- Hex bit
- Philips bit
- Size 8mm & 10mm wrench
- Plastic PRY tool
- Narrow screwdriver



**Remember:** Use plastic PRY tool to avoid marks on the panels or damaging the plastic clips. Take your time and don't rush things. Don't use brutal force to remove a grill, trim or door panel.



# Installation

## *Dismounting door panel*

Start the dismount of the door cover by removing the decor trim panel.

Remove the door decor trim panel by using a PRY tool. Be careful with the "hook" on the outer end of the decor trim panel.

The rear door is done in a similar way.

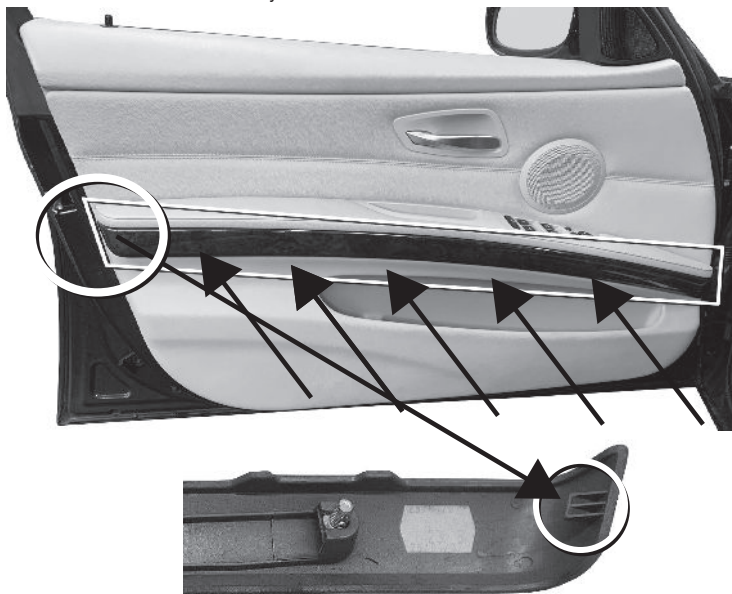

Remove the T20 screws. You need to remove the door handle as well, if the panel is equipped with one. Use PRY tool and be careful. T20 screw at the top of the handle and in some models a screw at the bottom of the handle.

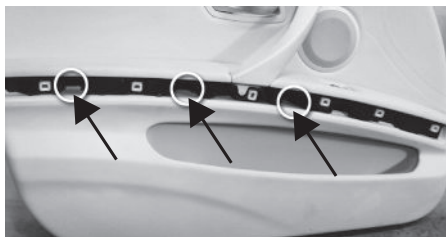

Remove the door panel. Start on the inside. Use a PRY tool. Insert the PRY tool behind the panel and carefully bend the tool towards you. If your car has a lock pin (6), make sure to remove it before lifting the door cover. There are several electric and mechanical connectors on the backside of the door panel. Disconnect the cables to the door handle, speaker, window control and door light.

## Removing speaker

The speakers are either mounted in the door panel or in the steel door frame.

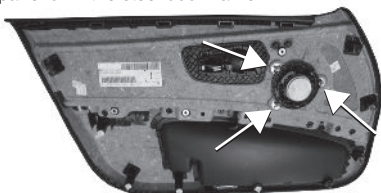

Use a size 8mm or 10mm wrench to remove the three bolts that are holding the speaker. Save the bolts for later assembly.

Speakers mounted in the door frame are fixed with T20 screws. Save the screws for later assembly.

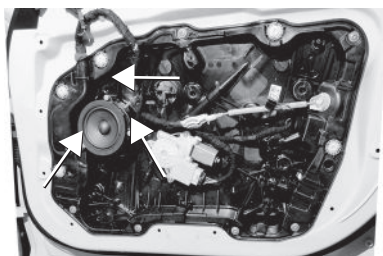

## Assemble DLS speaker











The DLS CRPP-BMW1.4 Custom upgrade kit is suitable for most BMW and MINI-models.

The kit contains many different parts, read the compatibility list on page 15, to see what configuration that fits your car.

On the following pages, you will find a guide on how to assemble the speaker to make it fit your car. Be careful when assembling, take your time and do no rush. All included parts will not be used.

The speaker models are called A1, A2 & B1

### Included parts

- |   |                                      |            |
|---|--------------------------------------|------------|
|    | Plastic adaptor                      | A1, A2     |
|   | Steel adaptor                        | B1         |
|  | Rubber gasket<br>(118x1.5mm)         | A1         |
|  | Foam gasket<br>(115x13mm)            | A2         |
|  | Foam gasket<br>(115x4mm)             | A1, A2     |
|  | EVA gasket<br>(102x1.5mm)            | B1         |
|  | EVA gasket<br>(97x1mm)               | A1, A2, B1 |
|  | Screws<br>(M3)                       | A1, A2, B1 |
|  | Cable connectors<br>(20cm Extension) | A1         |



## A1

Below is the assembly for a typical application of A1, however any combination of gasket may be useful for a particular installation.



Mount the EVA gasket (97mm x 1mm) on the underside of the basket. Peel off the protective cover of the self adhesive tape. Put it on the underside of the basket, press firmly all around so that the EVA gasket sticks thoroughly.



Remove the centerpiece of the small ring of the EVA gasket. This piece will not be used. Use a narrow tool to pick up the small ring from the same EVA gasket.

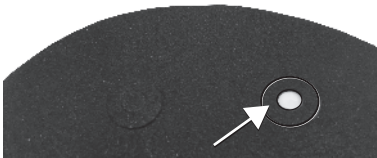

Place the small foam rings over the four threads on the basket.

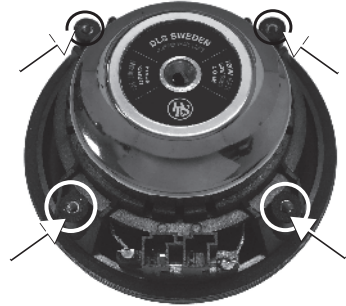

Place the plastic adaptor over the speaker and fix the frame with four included screws.

Mount the rubber gasket (118mm x 1.5mm) on the underside of the basket.



Mount the foam gasket (115mm x 4mm) on the top of the basket. Peel off the protective cover of the self adhesive tape. Press firmly all around so that the foam gasket sticks thoroughly.





## A2

Below is the assembly for a typical application of A2, however any combination of gasket may be useful for a particular installation.



Mount the EVA gasket (97mm x 1mm) on the underside of the basket. Peel off the protective cover of the self adhesive tape. Put it on the underside of the basket, press firmly all around so that the EVA gasket sticks thoroughly.



Remove the centerpiece of the small ring of the EVA gasket. This piece will not be used. Use a narrow tool to pick up the small ring from the same EVA gasket.

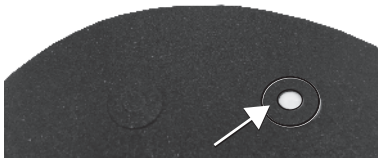

Place the small foam rings over the four threads on the basket.

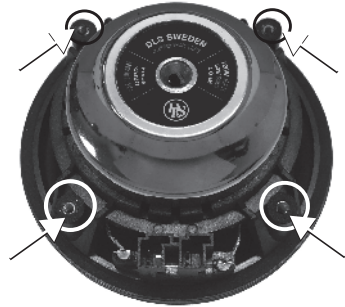

Place the plastic frame over the speaker and fix the frame with four included screws.

Attach the cable connector and place it in the gap of the plastic frame.

Mount the foam gasket (115mm x 4mm) on the underside of the basket.



Mount the foam gasket (115mm x 13mm) on the top of the basket. Peel off the protective cover of the self adhesive tape. Press firmly all around so that the foam gasket sticks thoroughly.





## B1

Below is the assembly for a typical application of B1, however any combination of gasket may be useful for a particular installation.



Mount the EVA gasket (97mm x 1mm) on the underside of the basket. Peel off the protective cover of the self adhesive tape. Put it on the underside of the basket, press firmly all around so that the EVA gasket sticks thoroughly.



Remove the centerpiece of the small ring of the EVA gasket. This piece will not be used. Use a narrow tool to pick up the small ring from the same EVA gasket.

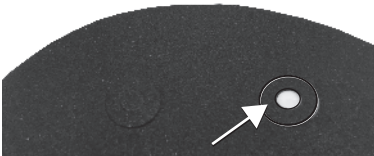

Place the small foam rings over the four threads on the basket.

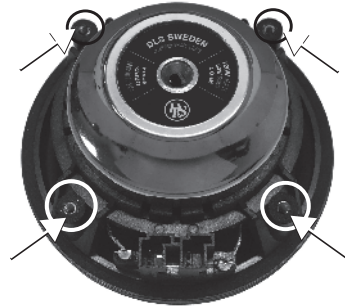

Mount the steel adaptor over the speaker and fix the frame with four included screws.



Mount the EVA gasket (102mm x 1.5mm) on the underside of the basket. Peel off the protective cover of the self adhesive tape. Press firmly all around so that the EVA gasket sticks thoroughly.

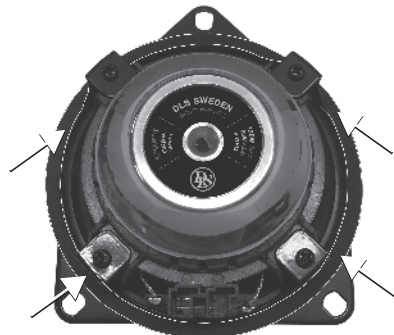



## Changing speaker

Mount the DLS speakers back in the original place (Door panel or door frame). Use the bolts to attach the DLS speaker in the door panel. Use a size 8mm or 10mm wrench to re-screw the three bolts to fix the speaker. When the speakers are mounted in the door frame, use the T20 screw to refix the speaker.

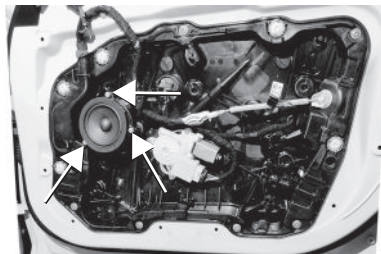
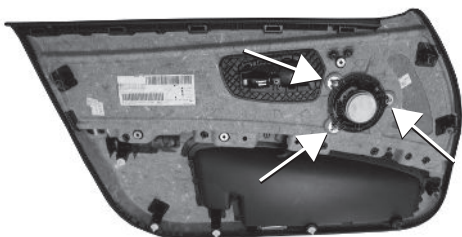

## High pass filter for midrange speaker

If the new speakers are powered by the factory installed radio/amplifier we recommend to use the included cable adaptor with installed high pass crossover for the midrange speaker. This crossover lowers the output below 250Hz by 6db slope, to reduce resonances in the door panel and prevent the midrange speaker from playing the lower bass tones.

Connect the factory speaker harness to the female connector of the adaptor and the male connector to the new DLS midrange speaker. If the factory amplifier is replaced with a new one with built in high pass crossover or more advanced DSP settings this cable won't be needed.

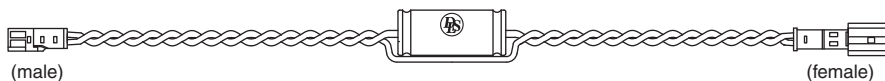

### Hint!

If you are also changing the tweeter and you have the speaker mounted in the door panel, wait with reconnecting the speaker harness and remounting the door panel.



## Removing tweeter

Remove the tweeter cover. (Before you start with changing the tweeter, the door panel needs to be removed.) Usually the tweeter cover is fixed with 2 or 3 clips, behind the tweeter cover. Start by removing the tweeter cover. On some models you need to remove the whole window trim. Use a PRY tool (or by hand) to remove it and be careful. Take it easy and use minimal force. When loose, disconnect the speaker harness from the tweeter. In cars with sound systems without tweeters in the front doors, the tweeter plastic covers or trim can be bought from BMW dealers or spare parts stores.

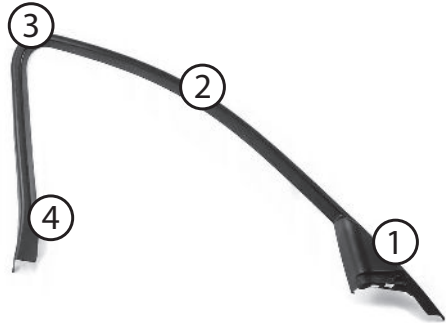

Remove the soft inside cover to find the tweeter. Gently press out the "hooks" to loosen the tweeter. Unplug the tweeter harness.





## Changing tweeter

Place the DLS tweeter in the OEM mounting bracket. Make sure that the speaker harness is facing down. Press the tweeter gently down and let all four hooks grab on the back of the tweeter. Reinstall the soft inside cover. Make sure that the fitment is as before. It's crucial when you remount the tweeter cover. The new DLS tweeter comes with a crossover installed on the speaker cable.

Connect the tweeter cable together with the midrange speaker connector. Use the included adhesive foam pads to secure the crossover and cables in the door panel or door frame.

Start putting the tweeter cover and the window trim back. Be careful when reaching the top outer corner on the window, make sure that the plastic on the outside gets in the correct position for perfect with the rubber sealing around the window frame.



## Remounting door panel

Now start the assembly of the door panel.

Reconnect all wires harness.

Connect all plugs to the door cover, reconnect the unlocking device, place the door cover from the top, by the window seal and push it down gently. Make sure the clips are in place and can engage. Give the door panel a push by the hand to attach to the clips. Mount and fasten all screws/bolts at the correct places.

### Hint!

Be careful when the door panel is installed so that no cable get squeezed and/or pressed against the midrange speaker when it's installed in the door frame.



## Removing rear speaker

Remove the speaker grill by using a PRY tool. As always, be careful when removing trim/covers or grills. Normally the screws are T20, but T15 or even Philips screws are used. Unscrew them and save them for later assembly. Lift up the speakers and unplug the speaker harness from both speakers (or the speaker, if just one is mounted)

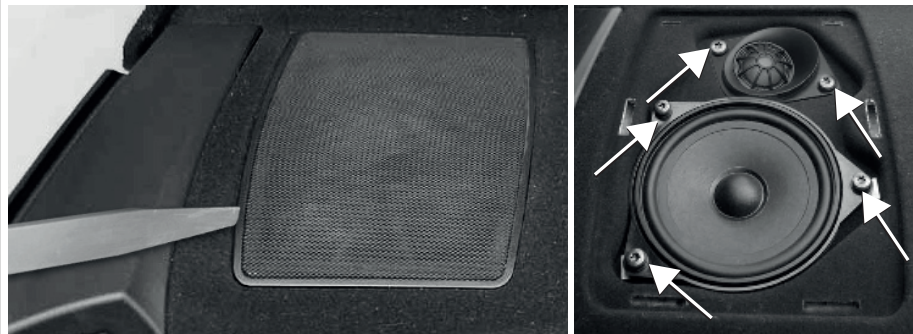

## Changing rear speaker

Plug in the OEM harness in the new speaker from DLS to the OEM harness. Plug in cable from the new DLS tweeter to the new speaker. (Or use the connection cable to connect the tweeter and the DLS midrange speaker)

The cable to the tweeter must be placed under the shelf panel, before the new speaker is installed. Carefully place the screws in the threads, so you don't drop them. Fix the speaker with the screws/bolts. Finally attach the speaker grill.





## Removing center speaker

Some sound systems don't have a tweeter or even a hole for the tweeter. Make sure that the DLS speakers fit your sound system.

Remove the speaker grill by using a PRY tool. Be careful when removing the cover/grille. Normally the screws are T20, but T15 or even Philips screws and bolts are used in some cars.

**Hint!** Be careful so you don't drop the screws/bolts. You don't want to have the them rattling around in your dashboard.

Unscrew them and save them for later assembly when you mount the new DLS speakers.

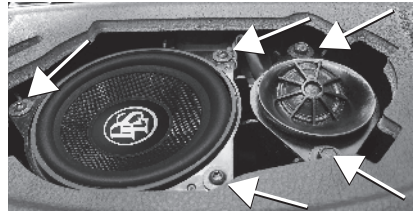
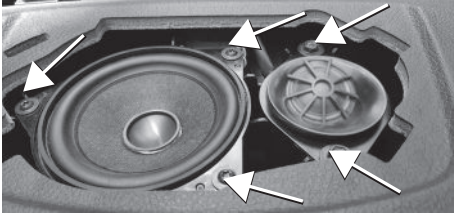

## Changing center speaker

Take out the speakers and unplug the speaker harness from both speakers (or the speaker, if just one is mounted)

Use the speaker harness to plug in the new driver from DLS. Plug in cable from the new DLS tweeter to the DLS speaker. (Or use the connection cable to connect the tweeter and the DLS driver)

Use OEM screws or bolts to reattach the speakers. Be careful so the speaker harnesses don't get stuck. Put the speaker grill back in place and press it down gently.

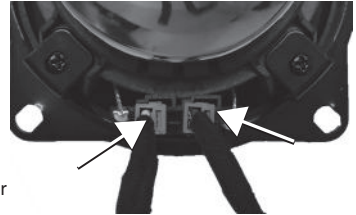



## Crossover

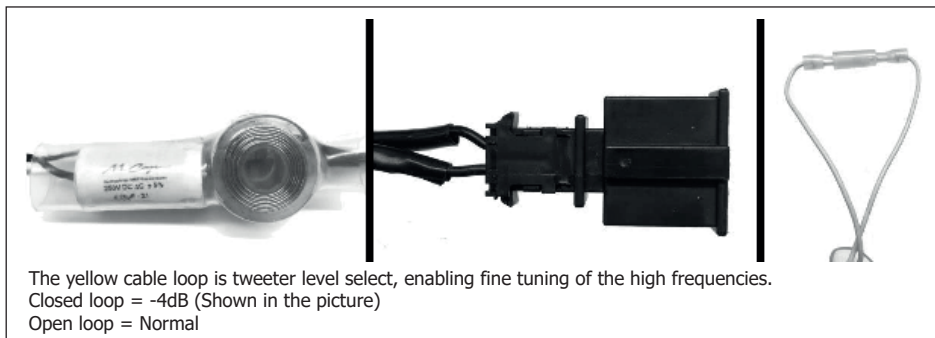

## Running-in time

Allow the component kit to play for at least 15-20 hours in order to perform at its possibly best. This run-in can be made with tone sweep or with just music.

Start at a moderate volume and increase the volume step by step during the running in period. After the 15-20 hour run in session the performance and characteristics will be in the correct condition.



**Finally, it's time to play some good music and enjoy!**

## DLS Support

For technical assistance, ask your car audio dealer where the product was sold or the distributor in your country. You can always contact the DLS Helpdesk in Sweden at e-mail: [info@dls.se](mailto:info@dls.se). Information can also be found on our WEB-site [www.dls.se](http://www.dls.se). We follow a policy of continuous advancement in development. For this reason, all or part of the specifications and designs may be changed without prior notice.



# Specifications

## Art. no CK-CRPP-BMW1.4

Woofer 4" / 100mm with fibreglass cone  
Tweeter 1" / 25mm silk dome tweeter with accessories  
RMS Power 60W  
MAX Power 120W  
Impedance 4 Ohm  
Sensitivity 86dB 1W/1m  
Freq. range 80Hz-25kHz  
Crossover 4.8kHz 6dB/Oct with Mundorf caps

## DLS Cruise CRPP-BMW1.4 Tweeter

Technical Specification:  
Size 1" / 25.4mm  
Voice Coil Material CCAW voice coil / Aluminium former  
Frame Fibreglass Reinforced ABS  
Magnet Neodymium / Copper shorting ring  
Cone Natural silk dome  
Impedance 4 Ohm  
Freq. range 2kHz-25kHz

### Electro-Acoustic Parameters:

Re 3.5 Ohm  
Fs 1992Hz  
SPL 94dB 1W/1m

## DLS Cruise CRPP-BMW1.4 Midrange

### Technical Specification

Size 4" / 100mm  
RMS Power 60W  
MAX Power 120W  
Voice Coil Size 1" / 25mm  
Voice Coil Material CCAW voice coil / Kapton former  
Basket Fibreglass Reinforced ABS  
Magnet Ferrite  
Cone Fibreglass  
Suspension Rubber  
Impedance 3 Ohm  
Freq. range 80Hz-8000Hz

### Electro-Acoustic Parameters

Re 3.1 Ohm  
Fs 99Hz  
Mms 6.3gr  
Cms 0.41  
Vas 1.69L  
Qts 0.68  
Qes 0.74  
Qms 8.48  
Bl 4.05T.m  
Spl 86dB 1W/1m  
Sd 54cm<sup>2</sup>

## Impedance VS Frequency

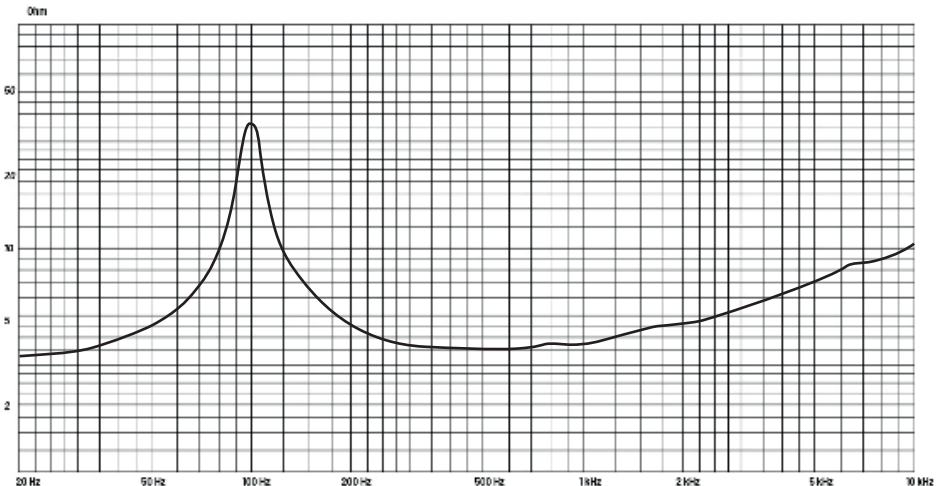

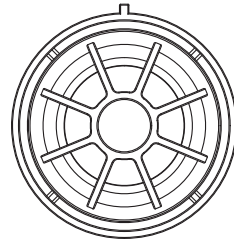
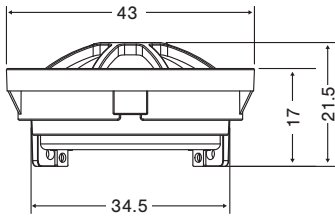

A/B

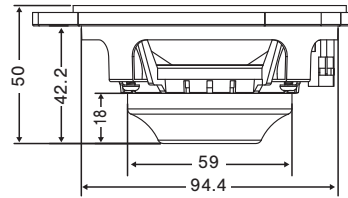
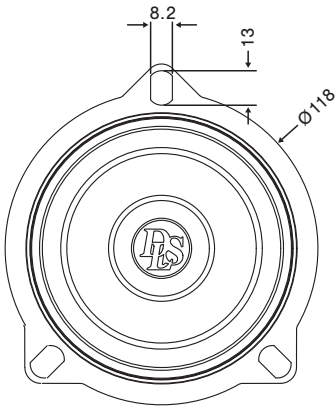

A

B

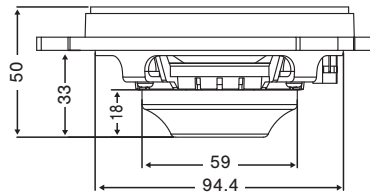
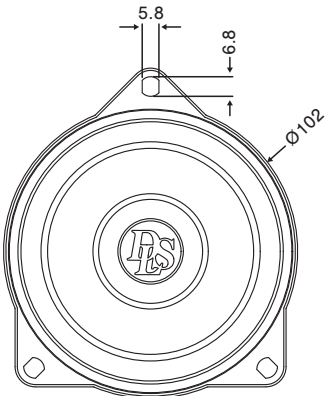

(mm)



## **DLS Cruise CRPP-BMW1.4 compatible car models**

| BMW Serie | Body | Year           | Front | Back door | Back        | Center |
|-----------|------|----------------|-------|-----------|-------------|--------|
| 1-Serie   | E81  | 2007 - 2011    | A1    |           | B1 (Shelf)  | B1     |
| 1-Serie   | E82  | 2007 - 2013    | A1    |           | B1 (Shelf)  | B1     |
| 1-Serie   | E87  | 2005 - 2011    | A1    |           | B1 (Shelf)  | B1     |
| 1-Serie   | E88  | 2004 - 2013    | A1    |           | A1 (Side)   | B1     |
| 1-Serie   | F52  | 2017 - Present | A2    | A2        |             | B1     |
| 1-Serie   | F20  | 2014 - Present | A2    |           | B1 (Shelf)  | B1     |
| 1-Serie   | F21  | 2014 - Present | A2    |           | B1 (Shelf)  | B1     |
| 1-Serie   | F40  | 2019 - Present | A2    | A2        |             | B1     |
| 2-Serie   | F22  | 2014 - Present | A2    |           | B1 (Shelf)  | B1     |
| 2-Serie   | F87  | 2015 - Present | A2    |           | B1 (Shelf)  | B1     |
| 2-Serie   | F23  | 2014 - Present | A2    |           | A2 (Side)   | B1     |
| 2-Serie   | F44  | 2015 - Present | A2    | A2        |             | B1     |
| 2-Serie   | F45  | 2015 - Present | A2    |           | A2 (Side)   | B1     |
| 2-Serie   | F46  | 2015 - Present | A2    |           | A2 (Side)   | B1     |
| 3-Serie   | E90  | 2005 - 2011    | A1    |           | B1 (Shelf)  | B1     |
| 3-Serie   | E91  | 2005 - 2012    | A1    | A1        |             | B1     |
| 3-Serie   | E92  | 2006 - 2013    | A1    |           | A1 (Side)   | B1     |
| 3-Serie   | E93  | 2007 - 2013    | A1    |           | A1 (Side)   | B1     |
| 3-Serie   | F30  | 2012 - 2016    | A2    | A2        | B1 (Shelf)  | B1     |
| 3-Serie   | F31  | 2012 - 2016    | A2    | A2        |             | B1     |
| 3-Serie   | F34  | 2012 - 2016    | A2    | A2        | B1 (Shelf)  | B1     |
| 3-Serie   | F35  | 2012 - 2019    | A2    | A2        | B1 (Shelf)  | B1     |
| 3-Serie   | F80  | 2014 - 2018    | A2    | A2        | B1 (Shelf)  | B1     |
| 3-Serie   | G20  | 2019 - Present | A2    | A2        | B1 (Shelf)  | B1     |
| 3-Serie   | G21  | 2020 - Present | A2    | A2        |             | B1     |
| 3-Serie   | G28  | 2022 - Present | A2    | A2        | B1 (Shelf)  | B1     |
| 3-Serie   | G80  | 2021 - Present | A2    | A2        | B1 (Shelf)  | B1     |
| 4-Serie   | F32  | 2014 - 2020    | A2    |           | A2 (Side)   | B1     |
| 4-Serie   | F33  | 2014 - 2020    | A2    |           | A2 (Side)   | B1     |
| 4-Serie   | F36  | 2014 - 2020    | A2    | A2        | B1 (Shelf)  | B1     |
| 4-Serie   | F82  | 2014 - 2020    | A2    |           | A2 (Side)   | B1     |
| 4-Serie   | F83  | 2014 - 2020    | A2    |           | A2 (Side)   | B1     |
| 4-Serie   | G22  | 2021 - Present | A2    |           | A2 (Side)   | B1     |
| 4-Serie   | G23  | 2021 - Present | A2    |           | A2 (Side)   | B1     |
| 5-serie   | E60  | 2003 - 2010    | B1    |           | B1 (Shelf)  | B1     |
| 5-serie   | E61  | 2003 - 2010    | B1    |           | B1 (Pillar) | B1     |
| 5-serie   | F07  | 2009 - 2016    | B1    | B1        | B1 (Pillar) | B1     |
| 5-serie   | F10  | 2010 - 2016    | A1    | A1        | B1 (Shelf)  | B1     |
| 5-serie   | F11  | 2011 - 2016    | A1    | A1        | B1 (Shelf)  | B1     |
| 5-serie   | G30  | 2017 - Present | A2    | A2        | B1 (Shelf)  | B1     |
| 5-serie   | G31  | 2017 - Present | A2    | A2        | B1 (Roof)   | B1     |
| 6-Serie   | E63  | 2004 - 2010    | A1    |           | A1 (Shelf)  | B1     |
| 6-Serie   | E64  | 2004 - 2010    | A1    | A1        | A1 (Shelf)  | B1     |



| Serie          | Body | Year           | Front | Back door | Back                | Center |
|----------------|------|----------------|-------|-----------|---------------------|--------|
| 6-Serie        | F06  | 2011 - 2015    | A2    | A2        | B1 (Shelf)          | B1     |
| 6-Serie        | F12  | 2012 - 2019    | A2    |           | A1 (Shelf)          | B1     |
| 6-Serie        | F13  | 2012 - 2019    | A2    |           | A1 (Shelf) B1(Side) | B1     |
| 6-Serie        | G32  | 2018 - Present | A2    | A2        |                     | B1     |
| 7-Serie        | E65  | 2002 - 2008    | B1    |           |                     | B1     |
| 7-Serie        | E66  | 2002 - 2008    | B1    |           |                     | B1     |
| 7-Serie        | E67  | 2001 - 2008    | B1    | B1        |                     | B1     |
| 7-Serie        | F01  | 2009 - 2015    | B1    | B1        | B1 (Shelf)          | B1     |
| 7-Serie        | F02  | 2009 - 2015    | B1    | B1        | B1 (Shelf)          | B1     |
| 7-Serie        | F04  | 2010 - 2015    | B1    | B1        | B1 (Shelf)          | B1     |
| 7-Serie        | G11  | 2016 - 2022    | A2    | A2        | B1 (Shelf)          | B1     |
| 7-Serie        | G12  | 2016 - 2022    | A2    | A2        | B1 (Shelf)          | B1     |
| i-8            | L15  | 2014 - Present | A2    |           | B1 (Side)           | B1     |
| X1             | E84  | 2009 - 2015    | A1    |           | B1 (Shelf)          | B1     |
| X1             | F48  | 2016 - 2022    | A2    | A2        | B1 (Shelf)          | B1     |
| X1             | F49  | 2016 - 2022    | A2    | A2        | B1 (Shelf)          | B1     |
| X3             | E83  | 2003 - 2010    | B1    | B1        |                     |        |
| X3             | F25  | 2011 - 2017    | A2    | A2        | B1 (Pillar)         | B1     |
| X3             | G01  | 2018 - Present | A2    | A2        |                     | B1     |
| X4             | F26  | 2014 - 2018    | A2    | A2        | A2 (Pillar)         | B1     |
| X4             | G02  | 2019 - Present | A2    | A2        |                     | B1     |
| X5             | E70  | 2007 - 2011    | B1    | B1        |                     | B1     |
| X5             | G05  | 2014 - 2018    | A2    | A2        | B1(Pillar)          | B1     |
| X6             | E71  | 2008 - 2014    | B1    | B1        |                     | B1     |
| X6             | G06  | 2020 - Present | A2    | A2        | B1(Pillar)          | B1     |
| Z4             | E89  | 2009 - 2016    | B1    | B1        |                     |        |
| MINI           |      |                |       |           |                     |        |
| Model          | Body | Year           | Front | Back door |                     |        |
| Clubman        | R55  | 2006-2014      | B1    |           |                     |        |
| Hatch (3-door) | R56  | 2006-2010      | B1    |           |                     |        |
| Cabrio         | R57  | 2008-2014      | B1    |           |                     |        |
| Coupé          | R58  | 2011-2015      | B1    |           |                     |        |
| Roadster       | R59  | 2011-2015      | B1    |           |                     |        |
| Countryman     | R60  | 2010-2016      | B1    |           |                     |        |
| Paceman        | R61  | 2013-2014      | B1    |           |                     |        |
| Clubman        | F54  | 2016-2019      | A2    | A2        |                     |        |
| Hatch (5-door) | F55  | 2014-2019      | A2    | A2        |                     |        |
| Hatch (3-door) | F56  | 2014-2019      | A2    | A2        |                     |        |
| Cabrio         | F57  | 2019-2021      | A2    | A2        |                     |        |
| Countryman     | F60  | 2017-2021      | A2    | A2        |                     |        |



# Product markings



The crossed-out wheelee bin symbol means that the product, literature and packaging included must be taken to separate collection at the end of their working life. Do not dispose of these products as unsorted municipal waste: take them for recycling. For info on your nearest recycling point, check with your local waste authority.



This product has been granted with the CE certification mark to show that the product follows the health, safety, and environmental protection standards for products sold within the European Economic Area (EEA).



DLS products complies with the relevant provisions of the RoHS Directive for the European Union. In common with all Electrical and Electronic Equipment (EEE) the product should not be disposed of as household waste. Alternative arrangements may apply in other jurisdictions.



DLS is a global partner of the European Mobile Media Association, an organisation that focus on promoting the custom made mobile media installations to consumers.

We follow a policy of continuous advancement in development. For this reason all or part of specifications & designs may be changed without prior notice. We reserve for possible typos, factual or numeric errors that may have been printed on any products, package designs, user manuals and/or other included accessories.



CRUISE